

EMC Test Report

Client Name : FOSHAN KAICHENG LIGHTING CO., LTD
Address : NO.16 Xingye Xi Road, Shishan Town, Nanhai District,
Foshan, Guangdong , P.R.China.
Product Name : LED Floodlight
Date : Aug. 19, 2020



Shenzhen Anbotek Compliance Laboratory Limited

Contents

- 1. General Information.....6
 - 1.1. Client Information..... 6
 - 1.2. Description of Device (EUT)..... 6
 - 1.3. Auxiliary Equipment Used During Test..... 6
 - 1.4. Description of Test Mode..... 7
 - 1.5. Test Summary..... 7
 - 1.6. Test Equipment List.....8
 - 1.7. Description of Test Facility..... 10
 - 1.8. EMS Performance Criteria..... 11
- 2. Power Line Conducted Emission Test..... 12
 - 2.1. Test Standard and Limit..... 12
 - 2.2. Test Setup..... 12
 - 2.3. EUT Configuration on Measurement..... 12
 - 2.4. Operating Condition of EUT..... 12
 - 2.5. Test Procedure..... 13
 - 2.6. Test Results..... 13
- 3. Radiated Emission Test..... 16
 - 3.1. Test Standard and Limit..... 16
 - 3.2. Test Setup..... 16
 - 3.3. EUT Configuration on Measurement..... 16
 - 3.4. Operating Condition of EUT..... 17
 - 3.5. Test Procedure..... 17
 - 3.6. Test Results..... 17
- 4. Magnetic Radiated Emission Test.....20
 - 4.1. Test Standard and Limit..... 20
 - 4.2. Test Setup..... 20
 - 4.3. EUT Configuration on Measurement..... 20
 - 4.4. Operating Condition of EUT..... 20
 - 4.5. Test Procedure..... 21
 - 4.6. Test Results..... 21
- 5. Harmonic Current Emission Test..... 25
 - 5.1. Test Standard..... 25
 - 5.2. Test Setup..... 25
 - 5.3. Operating Condition of EUT..... 25
 - 5.4. Test Results..... 25
- 6. Voltage Fluctuations & Flicker Test.....28
 - 6.1. Test Standard..... 28
 - 6.2. Test Setup..... 28
 - 6.3. Operating Condition of EUT..... 28

6.4. Test Results..... 28

7. Electrostatic Discharge Immunity Test..... 30

 7.1. Test Standard and Level..... 30

 7.2. Test Setup..... 30

 7.3. EUT Configuration on Measurement..... 30

 7.4. Operating Condition of EUT..... 30

 7.5. Test Procedure..... 31

 7.6. Test Results..... 31

8. RF Field Strength Susceptibility Test..... 33

 8.1. Test Standard and Level..... 33

 8.2. Test Setup..... 33

 8.3. EUT Configuration on Measurement..... 33

 8.4. Operating Condition of EUT..... 34

 8.5. Test Procedure..... 34

 8.6. Measuring Results..... 34

9. Electrical Fast Transient/Burst Immunity Test..... 36

 9.1. Test Standard and Level..... 36

 9.2. Test Setup..... 36

 9.3. EUT Configuration on Measurement..... 36

 9.4. Operating Condition of EUT..... 37

 9.5. Test Procedure..... 37

 9.6. Test Results..... 37

10. Surge Immunity Test..... 39

 10.1. Test Standard and Level..... 39

 10.2. Test Setup..... 39

 10.3. EUT Configuration on Measurement..... 39

 10.4. Operating Condition of EUT..... 39

 10.5. Test Procedure..... 40

 10.6. Test Results..... 40

11. Injected Currents Susceptibility Test..... 42

 11.1. Test Standard and Level..... 42

 11.2. Test Setup..... 42

 11.3. EUT Configuration..... 42

 11.4. Operating Condition of EUT..... 42

 11.5. Test Procedure..... 43

 11.6. Test Results..... 43

12. Voltage Dips And Interruptions Test..... 45

 12.1. Test Standard and Level..... 45

 12.2. Test Setup..... 45

 12.3. EUT Configuration on Measurement..... 45

 12.4. Operating Condition of EUT..... 46

 12.5. Test Procedure..... 46

12.6. Test Results.....46
APPENDIX I -- TEST SETUP PHOTOGRAPH.....48
APPENDIX II -- Photo documentation..... 53

TEST REPORT

Applicant : FOSHAN KAICHENG LIGHTING CO., LTD
Manufacturer : FOSHAN KAICHENG LIGHTING CO., LTD
Product Name : LED Floodlight
Model No. : BK02-200W, BK02-10W, BK02-20W BK02-30W, BK02-50W, BK02-100W
BK02-150W
Trade Mark : N.A.
Rating(s) : AC100-240V, 50/60Hz
**Test Standard(s) : EN IEC 55015: 2019;
EN IEC 61000-3-2: 2019;
EN 61000-3-3: 2013+A1:2019;
EN 61547: 2009;
(IEC 61000-4-2; IEC 61000-4-3; IEC 61000-4-4;
IEC 61000-4-5; IEC 61000-4-6; IEC 61000-4-11)**

The device described above is tested by Shenzhen Anbotek Compliance Laboratory Limited to determine the maximum emission levels emanating from the device and the severe levels of the device can endure and its performance criterion. The measurement results are contained in this test report and Shenzhen Anbotek Compliance Laboratory Limited is assumed full responsibility for the accuracy and completeness of these measurements. Also, this report shows that the EUT to be technically compliant with the EN IEC 55015, EN IEC 61000-3-2, EN 61000-3-3 and EN 61547 requirements.

This report applies to above tested sample only and shall not be reproduced in part without written approval of Shenzhen Anbotek Compliance Laboratory Limited.

Date of Receipt: Aug. 13, 2020

Date of Test: Aug. 13~17, 2020

Prepared By:

Winnie Huang

(Engineer / Winnie Huang)

Reviewer:

Well Wang

(Supervisor / Well Wang)

Approved & Authorized Signer:

KingKong Jin

(Manager / KingKong Jin)

1. General Information

1.1. Client Information

Applicant	:	FOSHAN KAICHENG LIGHTING CO., LTD
Address	:	NO.16 Xingye Xi Road, Shishan Town, Nanhai District, Foshan, Guangdong , P.R.China.
Manufacturer	:	FOSHAN KAICHENG LIGHTING CO., LTD
Address	:	NO.16 Xingye Xi Road, Shishan Town, Nanhai District, Foshan, Guangdong , P.R.China.
Factory	:	FOSHAN KAICHENG LIGHTING CO., LTD
Address	:	NO.16 Xingye Xi Road, Shishan Town, Nanhai District, Foshan, Guangdong , P.R.China.

1.2. Description of Device (EUT)

Product Name	:	LED Floodlight
Model No.	:	BK02-200W, BK02-10W, BK02-20W BK02-30W, BK02-50W, BK02-100W BK02-150W (Note: All samples are the same except the model number & appearance, so we prepare “BK02-200W” for test only.)
Trade Mark	:	N.A.
Test Power Supply	:	AC 230V, 50Hz
Test Sample No.	:	1-1-1
Product Description	:	Adapter: N/A
Remark: (1) For a more detailed features description, please refer to the manufacturer’s specifications or the User’s Manual.		

1.3. Auxiliary Equipment Used During Test

N/A	
-----	--

1.4. Description of Test Mode

Pretest Mode	Description
Mode 1	On

For Mode 1 Block Diagram of Test Setup

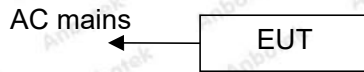

1.5. Test Summary

Test Items	Test Mode	Status
Power Line Conducted Emission Test (9KHz To 30MHz)	Mode 1	P
Radiated Emission Test (30MHz To 1000MHz)	Mode 1	P
Magnetic Radiated Emission Test (9KHz To 30MHz)	/	N
Harmonic Current Test	Mode 1	P
Voltage Fluctuations and Flicker Test	Mode 1	P
Electrostatic Discharge immunity Test	Mode 1	P
RF Field Strength susceptibility Test	Mode 1	P
Electrical Fast Transient/Burst Immunity Test	Mode 1	P
Surge Immunity Test	Mode 1	P
Injected Currents Susceptibility Test	Mode 1	P
Voltage Dips and Interruptions Test	Mode 1	P
P) Indicates "PASS".		
N) Indicates "Not applicable"		

1.6. Test Equipment List

Conducted Emission Measurement

Item	Equipment	Manufacturer	Model No.	Serial No.	Last Cal.	Cal. Interval
1.	L.I.S.N. Artificial Mains Network	Rohde & Schwarz	ENV216	100055	Nov. 04, 2019	1 Year
2.	L.I.S.N. Artificial Mains Network	Schwarzbeck	NSLK 8127	8127386	Nov. 04, 2019	1 Year
3.	EMI Test Receiver	Rohde & Schwarz	ESCI	100627	Nov. 04, 2019	1 Year
4.	RF Switching Unit	Compliance Direction	RSU-M2	38303	Nov. 04, 2019	1 Year
5.	Software Name EZ-EMC	Ferrari Technology	ANB-03A	N/A	N/A	N/A

Radiated Emission Measurement

Item	Equipment	Manufacturer	Model No.	Serial No.	Last Cal.	Cal. Interval
1.	EMI Test Receiver	Rohde & Schwarz	ESCI	100627	Nov. 04, 2019	1 Year
2.	Pre-amplifier	Schwarzbeck	BBV-9745	9745-075	Nov. 04, 2019	1 Year
3.	Bilog Broadband Antenna	SCHWARZBECK	VULB 9163	01109	Nov. 01, 2019	1 Year
4.	Software Name EZ-EMC	Ferrari Technology	EMEC-3A1	N/A	N/A	N/A

Magnetic Radiated Emission Measurement

Item	Equipment	Manufacturer	Model No.	Serial No.	Last Cal.	Cal. Interval
1.	EMI Test Receiver	Rohde & Schwarz	ESCI	100627	Nov. 04, 2019	1 Year
2.	Triple-Loop Antenna(2M)	EVERFINE	LLA-2	905003	Nov. 04, 2019	1 Year
3.	RF Switching Unit	Compliance Direction	RSU-M2	38303	Nov. 04, 2019	1 Year
4.	Software Name EZ-EMC	Ferrari Technology	ANB-03A	N/A	N/A	N/A

Harmonic and Flicker Measurement

Item	Equipment	Manufacturer	Model No.	Serial No.	Last Cal.	Cal. Interval
1.	Programmable AC Power source	IVYTECH	APS-5005A	632734	Nov. 04, 2019	1 Year
2.	Harmonic and Flicker Analyzer	EMC-PARTNER	HMONICS 1000-1P	164	Nov. 04, 2019	1 Year
3.	Harmonics-1000	N/A	Ed.3.0+4.0	N/A	N/A	N/A

Electrostatic Discharge Measurement

Item	Equipment	Manufacturer	Model No.	Serial No.	Last Cal.	Cal. Interval
1.	ESD Simulators	emtest	ESD NX30.1	11891	Mar. 07, 2020	1 Year

Item	Equipment	Manufacturer	Model No.	Serial No.	Last Cal.	Cal. Interval
1	Signal Generator	Agilent	N5182A	MY48180656	Nov. 04, 2019	1 Year
2	Amplifier	Micotoop	MPA-80-1000-250	MPA1903096	Nov. 04, 2019	1 Year
3	Amplifier	Micotoop	MPA-1000-6000-100	MPA1903122	Nov. 04, 2019	1 Year
4	Log-Periodic Antenna	Schwarzbeck	VULP9118E	00992	Apr.17, 2020	1 Year
5	Horn Antenna	Instruments corporation	GTH-0118	351600	Nov. 01, 2019	1 Year
6	Power Sensor	Agilent	E9301A	MY41498906	Nov. 04, 2019	1 Year
7	Power Sensor	Agilent	E9301A	MY41498088	Nov. 04, 2019	1 Year
8	Power Meter	Agilent	E4419B	GB40202909	Nov. 04, 2019	1 Year
9	Field Probe	ETS-Lindgren	HI-6006	00212747	Apr.17, 2020	1 Year
10	software	EMtrace	EM 3	N/A	N/A	N/A

Electrical Fast Transient/Burst Immunity Measurement

Item	Equipment	Manufacturer	Model No.	Serial No.	Last Cal.	Cal. Interval
1.1	EFT Burst Simulator	PRIMA	EFT61004B	PR10114282	Nov. 04, 2019	1 Year
1.2	EFT-Clamp	PRIMA	EFT-Clamp	/	Nov. 04, 2019	1 Year
2.1	EFT Burst Simulator	TESEQ	NSG 3060	1480	Nov. 04, 2019	1 Year
2.2	CDN	TESEQ	CDN 3061	1408	Nov. 04, 2019	1 Year

Surge Measurement

Item	Equipment	Manufacturer	Model No.	Serial No.	Last Cal.	Cal. Interval
1.	Surge Generator	TESEQ	NSG 3060	1480	Nov. 04, 2019	1 Year
2.	CDN	TESEQ	CDN 3061	1408	Nov. 04, 2019	1 Year
3.	Telecom port surge generator	PMI	TW101	190411	Apr.17,2020	1 Year

Injected Currents Susceptibility Measurement

Item	Equipment	Manufacturer	Model No.	Serial No.	Last Cal.	Cal. Interval
1.	C/S Conducted Immunity Test System	FRANKONIA	CIT-10	126A1196/2012	Nov. 04, 2019	1 Year
2.	CDN	FRANKONIA	CDN - M2+ M3	A2210178/2012	Nov. 04, 2019	1 Year
3.	6dB Attenuator	FRANKONIA	DAM 26W	1172202	Nov. 04, 2019	1 Year
4.	CIT-10	FRANKONIA	Version1.1.7	N/A	N.A	N/A
5.	EM-Clamp	FRANKONIA	EMCL-20	18101728-0103	May.17,2020	1 Year

Voltage Dips and Interruptions Measurement

Item	Equipment	Manufacturer	Model No.	Serial No.	Last Cal.	Cal. Interval
1.	CYCLE SAG Simulator	PRIMA	DRP61011AG	PR12046234	Nov. 04, 2019	1 Year

1.7. Description of Test Facility

The test facility is recognized, certified, or accredited by the following organizations:

FCC-Registration No.: 184111

Shenzhen Anbotek Compliance Laboratory Limited, EMC Laboratory has been registered and fully described in a report filed with the (FCC) Federal Communications Commission. The acceptance letter from the FCC is maintained in our files. Registration No. 184111, September 27, 2019.

ISED-Registration No.: 8058A

Shenzhen Anbotek Compliance Laboratory Limited, EMC Laboratory has been registered and fully described in a report filed with the (ISED) Innovation, Science and Economic Development Canada. The acceptance letter from the ISED is maintained in our files. Registration 8058A, March 07, 2019.

Test Location

Shenzhen Anbotek Compliance Laboratory Limited.

1/F, Building D, Sogood Science and Technology Park, Sanwei community, Hangcheng Street, Bao'an District, Shenzhen, Guangdong, China.518128

1.8. EMS Performance Criteria

- √ A: Normal performance within the specification limits
- √ B: Temporary degradation or loss of function or performance which is self-recoverable
- √ C: Temporary degradation or loss of function or performance which requires operator intervention or system reset
- √ D: Degradation or loss of function which is not recoverable due to damage of equipment (components) or software, or loss of data

Note: The manufacturer's specification may define effects on the EUT which may be considered insignificant, and therefore acceptable.

This classification may be used as a guide in formulating performance criteria, by committees responsible for generic, product and product-family standards, or as a framework for the agreement on performance criteria between the manufacturer and the purchaser, for example where no suitable generic, product or product-family standard exists.

2. Power Line Conducted Emission Test

2.1. Test Standard and Limit

Test Standard	EN IEC 55015
---------------	--------------

Limits for conducted emissions

Test Limit	Frequency	At mains terminals (dB μ V)	
		Quasi-peak Level	Average Level
	9kHz ~ 50kHz	110	--
	50kHz ~ 150kHz	90 ~ 80*	--
	150kHz ~ 0.5MHz	66 ~ 56*	56 ~ 46*
	0.5MHz ~ 5.0MHz	56	46
	5.0MHz ~ 30MHz	60	50

Remark: (1) At the transition frequency the lower limit applies.
(2) * decreasing linearly with logarithm of the frequency.

2.2. Test Setup

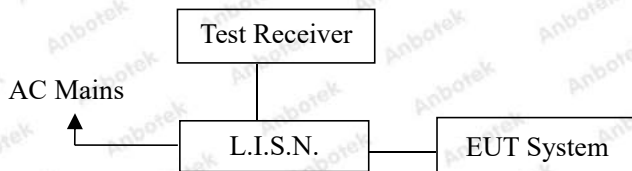

2.3. EUT Configuration on Measurement

The following equipments are installed on Conducted Emission Measurement to meet EN IEC 55015 requirements and operating in a manner which tends to maximize its emission characteristics in a normal application.

2.4. Operating Condition of EUT

- 2.4.1. Setup the EUT as shown in Section 2.2.
- 2.4.2. Turn on the power of all equipments.
- 2.4.3. Let the EUT work in test mode and measure it.

2.5. Test Procedure

The EUT is put on the table which is 0.8 meter high above the ground and connected to the AC mains through a Line Impedance Stabilization Network (L.I.S.N.). This provided a 50ohm coupling impedance for the tested equipments. Both sides of AC line are checked to find out the maximum conducted emission according to the EN IEC 55015 regulations during conducted emission measurement. And the voltage probe had been used for the load terminals measurement according to the EN IEC 55015 standard.

The bandwidth of the test receiver (R&S ESCI) is set at 200Hz in 9K~150KHz range and 9KHz in 150K~30MHz range.

The frequency range from 9KHz to 30MHz is checked.

All the test results are listed in Section 2.6.

2.6. Test Results

PASS

The test curves are shown in the following pages.

Conducted Emission Test Data

Test Site: 1# Shielded Room
 Test Specification: AC 230V, 50Hz
 Comment: Live Line
 Temp.: 21.6°C Hum.: 58%

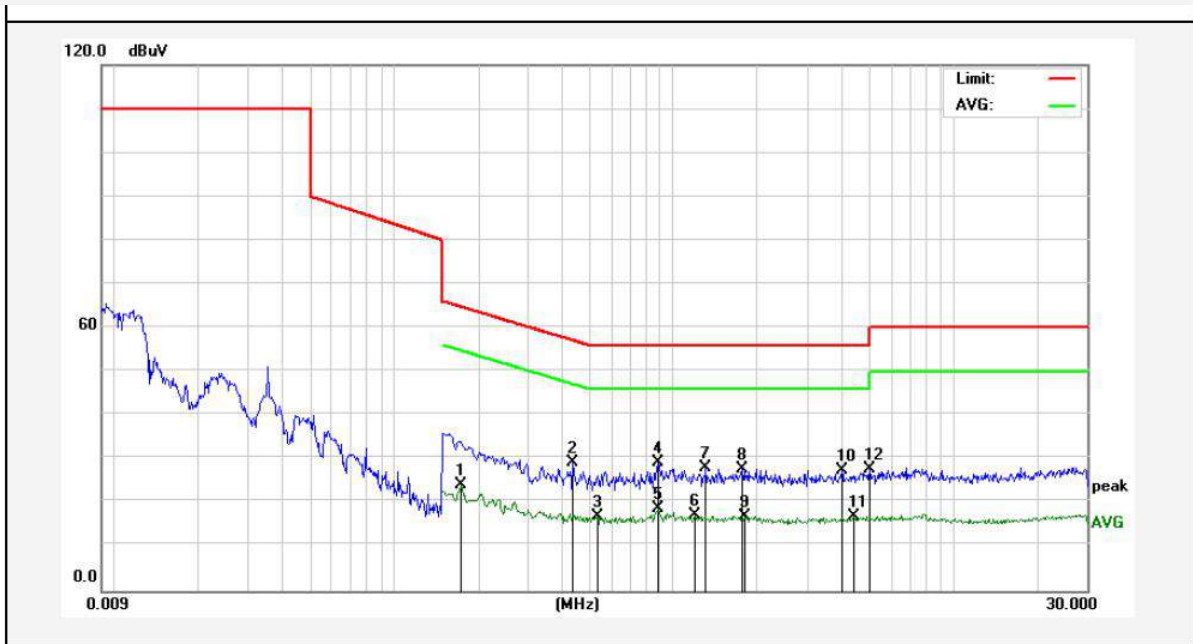

No.	Freq. (MHz)	Reading (dBUV)	Factor (dB)	Result (dBUV)	Limit (dBUV)	Over Limit (dB)	Detector	Remark
1	0.1740	4.36	19.90	24.26	54.76	-30.50	AVG	
2	0.4380	9.39	19.95	29.34	57.10	-27.76	QP	
3	0.5340	-3.01	19.99	16.98	46.00	-29.02	AVG	
4	0.8860	9.17	20.09	29.26	56.00	-26.74	QP	
5	0.8860	-1.29	20.09	18.80	46.00	-27.20	AVG	
6	1.1980	-2.76	20.12	17.36	46.00	-28.64	AVG	
7	1.3099	8.06	20.13	28.19	56.00	-27.81	QP	
8	1.7580	7.59	20.14	27.73	56.00	-28.27	QP	
9	1.8020	-3.10	20.14	17.04	46.00	-28.96	AVG	
10	3.9900	7.37	20.18	27.55	56.00	-28.45	QP	
11	4.4220	-3.18	20.19	17.01	46.00	-28.99	AVG	
12	4.9980	7.40	20.21	27.61	56.00	-28.39	QP	

Note: Result=Reading+Factor Over Limit=Result-Limit

Conducted Emission Test Data

Test Site: 1# Shielded Room
 Test Specification: AC 230V, 50Hz
 Comment: Neutral Line
 Temp.: 21.6°C Hum.: 58%

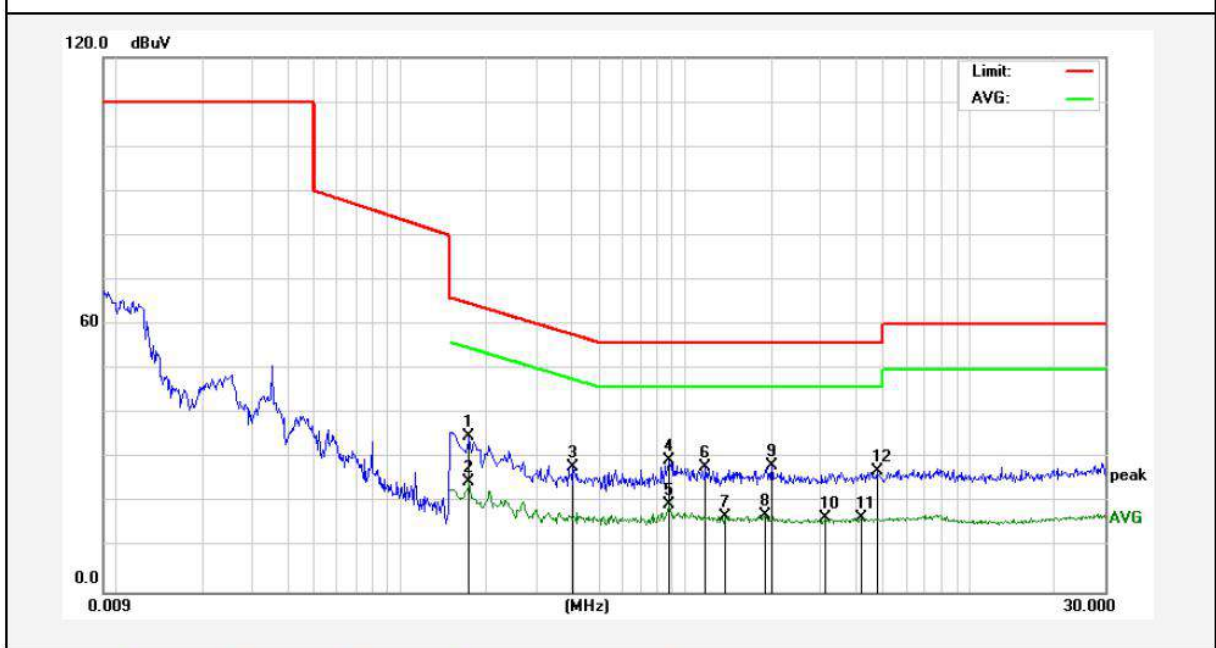

No.	Freq. (MHz)	Reading (dBuV)	Factor (dB)	Result (dBuV)	Limit (dBuV)	Over Limit (dB)	Detector	Remark
1	0.1740	14.99	19.90	34.89	64.76	-29.87	QP	
2	0.1740	4.74	19.90	24.64	54.76	-30.12	AVG	
3	0.4060	8.09	19.94	28.03	57.73	-29.70	QP	
4	0.8860	9.44	20.09	29.53	56.00	-26.47	QP	
5	0.8860	-0.30	20.09	19.79	46.00	-26.21	AVG	
6	1.1860	8.04	20.12	28.16	56.00	-27.84	QP	
7	1.3860	-3.09	20.13	17.04	46.00	-28.96	AVG	
8	1.9100	-2.94	20.14	17.20	46.00	-28.80	AVG	
9	2.0140	8.25	20.14	28.39	56.00	-27.61	QP	
10	3.1260	-3.63	20.16	16.53	46.00	-29.47	AVG	
11	4.1579	-3.46	20.18	16.72	46.00	-29.28	AVG	
12	4.7340	6.93	20.20	27.13	56.00	-28.87	QP	

Note: Result=Reading+Factor Over Limit=Result-Limit

3. Radiated Emission Test

3.1. Test Standard and Limit

Test Standard	EN IEC 55015
---------------	--------------

Radiated Emission Test Limit

Test Limit	Frequency (MHz)	DISTANCE (Meters)	FIELD STRENGTHS LIMIT (dB μ V/m)
	30 ~ 230	3	40
	230 ~ 1000	3	47

Remark: (1) The smaller limit shall apply at the combination point between two frequency bands.
 (2) Distance refers to the distance in meters between the measuring instrument antenna and the closed point of any part of the EUT.

3.2. Test Setup

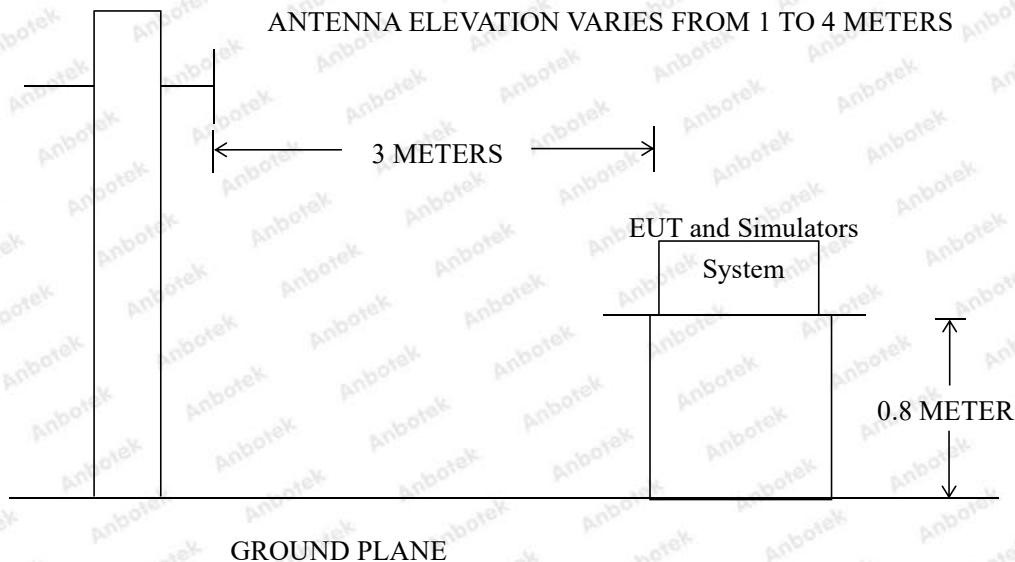

3.3. EUT Configuration on Measurement

The EN IEC 55015 regulations test method must be used to find the maximum emission during radiated emission measurement.

3.4. Operating Condition of EUT

3.4.1. Setup the EUT as shown in Section 3.2.

3.4.2. Turn on the power of all equipments.

3.4.3. Let the EUT work in test mode and measure it.

3.5. Test Procedure

The EUT is placed on a turn table which is 0.8 meter high above the ground. The turn table can rotate 360 degrees to determine the position of the maximum emission level. The EUT is set 3 meters away from the receiving antenna which is mounted on an antenna tower. The antenna can be moved up and down from 1 to 4 meters to find out the maximum emission level. Bilog antenna is used as a receiving antenna. Both horizontal and vertical polarization of the antenna are set on test.

The bandwidth of the Receiver (ESCI) is set at 120kHz.

The EUT is tested in Chamber.

The test results are listed in Section 3.6.

3.6. Test Results

PASS

The frequency range from 30MHz to 1000MHz is investigated.

The test curves are shown in the following pages.

Test item: Radiation Test **Polarization:** Horizontal
Standard: (RE)EN IEC 55015 **Power Source:** AC 230V, 50Hz
Distance: 3m **Temp.(°C)/Hum.(%RH):** 23.5(°C)/58%RH

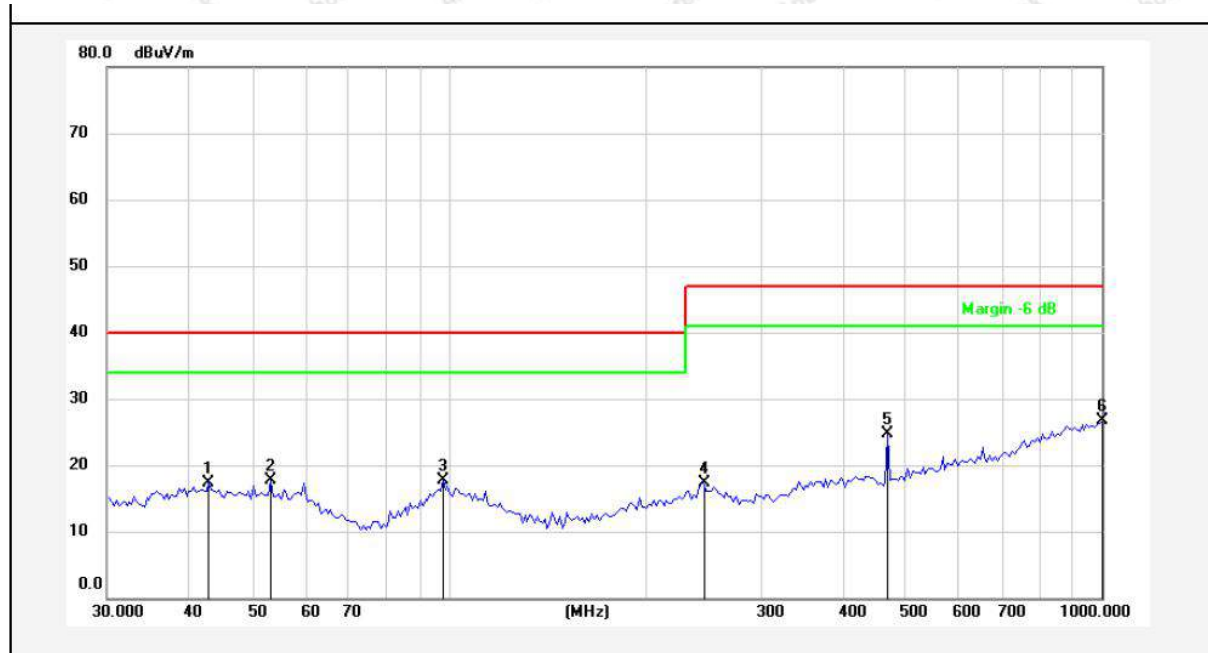

No.	Freq. (MHz)	Reading (dBuV)	Factor ()	Result (dBuV/m)	Limit (dBuV/m)	Over Limit (dB)	Detector	Height (cm)	degree (deg)	Remark
1	42.9750	32.82	-15.60	17.22	40.00	-22.78	peak			
2	53.5052	33.78	-16.06	17.72	40.00	-22.28	peak			
3	97.9699	33.48	-15.83	17.65	40.00	-22.35	peak			
4	243.8043	33.50	-16.19	17.31	47.00	-29.69	peak			
5	470.5232	39.82	-15.06	24.76	47.00	-22.24	peak			
6	1000.0000	33.36	-6.64	26.72	47.00	-20.28	peak			

Note: **Result=Reading+Factor** **Over Limit=Result-Limit**

Test item: Radiation Test **Polarization:** Vertical
Standard: (RE)EN IEC 55015 **Power Source:** AC 230V, 50Hz
Distance: 3m **Temp.(°C)/Hum.(%RH):** 23.5(°C)/58%RH

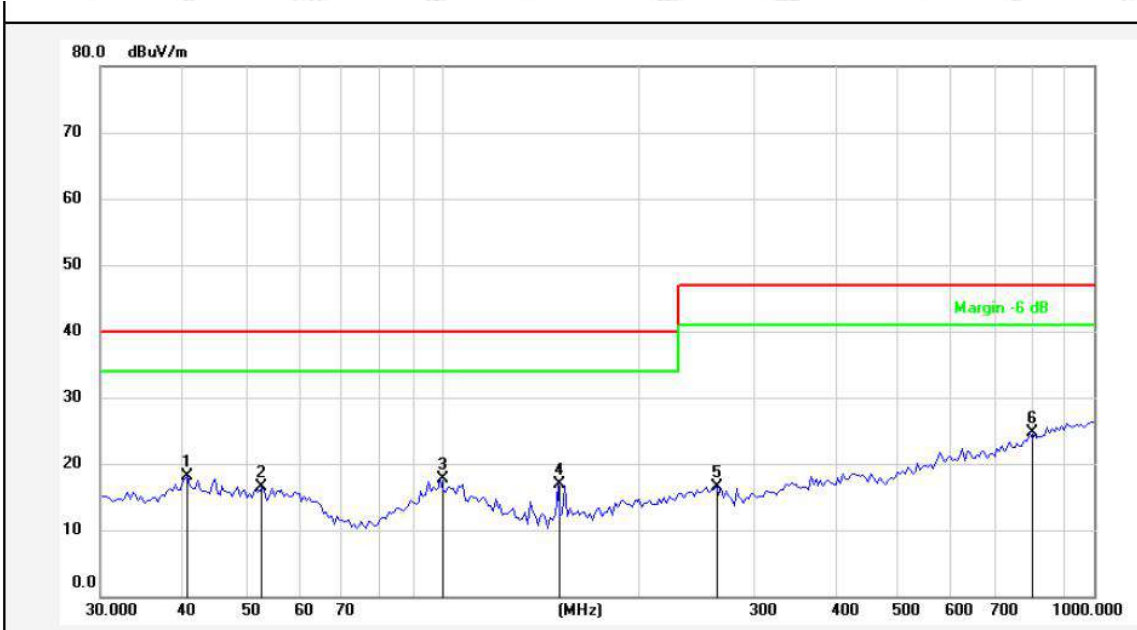

No.	Freq. (MHz)	Reading (dBuV)	Factor ()	Result (dBuV/m)	Limit (dBuV/m)	Over Limit (dB)	Detector	Height (cm)	degree (deg)	Remark
1	40.7730	33.65	-15.57	18.08	40.00	-21.92	peak			
2	53.0382	32.53	-16.04	16.49	40.00	-23.51	peak			
3	99.7028	33.42	-15.71	17.71	40.00	-22.29	peak			
4	150.5378	37.27	-20.33	16.94	40.00	-23.06	peak			
5	263.8190	33.01	-16.44	16.57	47.00	-30.43	peak			
6	796.1830	33.69	-9.04	24.65	47.00	-22.35	peak			

Note: Result=Reading+Factor Over Limit=Result-Limit

4. Magnetic Radiated Emission Test

4.1. Test Standard and Limit

Test Standard	EN IEC 55015
---------------	--------------

Limits for Magnetic Radiated Emission

Test Limit	Frequency	Limits for loop diameter (dB μ A)
		2m
	9KHz ~ 70KHz	88
	70KHz ~ 150KHz	88 ~ 58*
	150KHz ~ 3.0MHz	58 ~ 22*
	3.0MHz ~ 30MHz	22

Remark: (1) At the transition frequency the lower limit applies.
(2) * decreasing linearly with logarithm of the frequency.

4.2. Test Setup

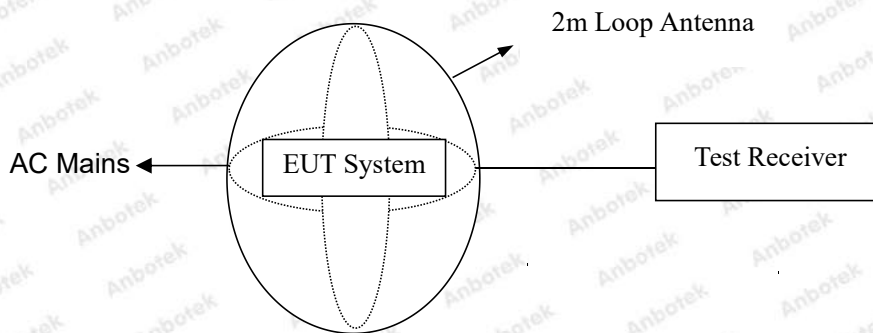

4.3. EUT Configuration on Measurement

The following equipments are installed on Magnetic Radiated emission Measurement to meet EN IEC 55015 requirements and operating in a manner which tends to maximize its emission characteristics in a normal application.

4.4. Operating Condition of EUT

- 4.4.1. Setup the EUT as shown in Section 4.2.
- 4.4.2. Turn on the power of all equipments.
- 4.4.3. Let the EUT work in test mode and measure it.

4.5. Test Procedure

The EUT is placed on a wood table in the center of a loop antenna. The induced current in the loop antenna is measured by means of a current probe and the test receiver. Three field components are checked by means of a coaxial switch.

The frequency range from 9KHz to 30MHz is investigated. The receiver is measured with the quasi-peak detector. For frequency band 9KHz to 150KHz, the bandwidth of the test receiver (ESCI) is set at 200Hz. For frequency band 150KHz to 30MHz, the bandwidth is set at 9KHz.

All the test results are listed in Section 4.6.

4.6. Test Results

PASS

The frequency range from 9KHz to 30MHz is investigated.

The test curves are shown in the following pages.

Magnetic Radiated Emission Test

Test Site: 1# Shielded Room
 Test Specification: AC 230V, 50Hz
 Comment: X
 Temp.: 21.6°C Hum.: 58%

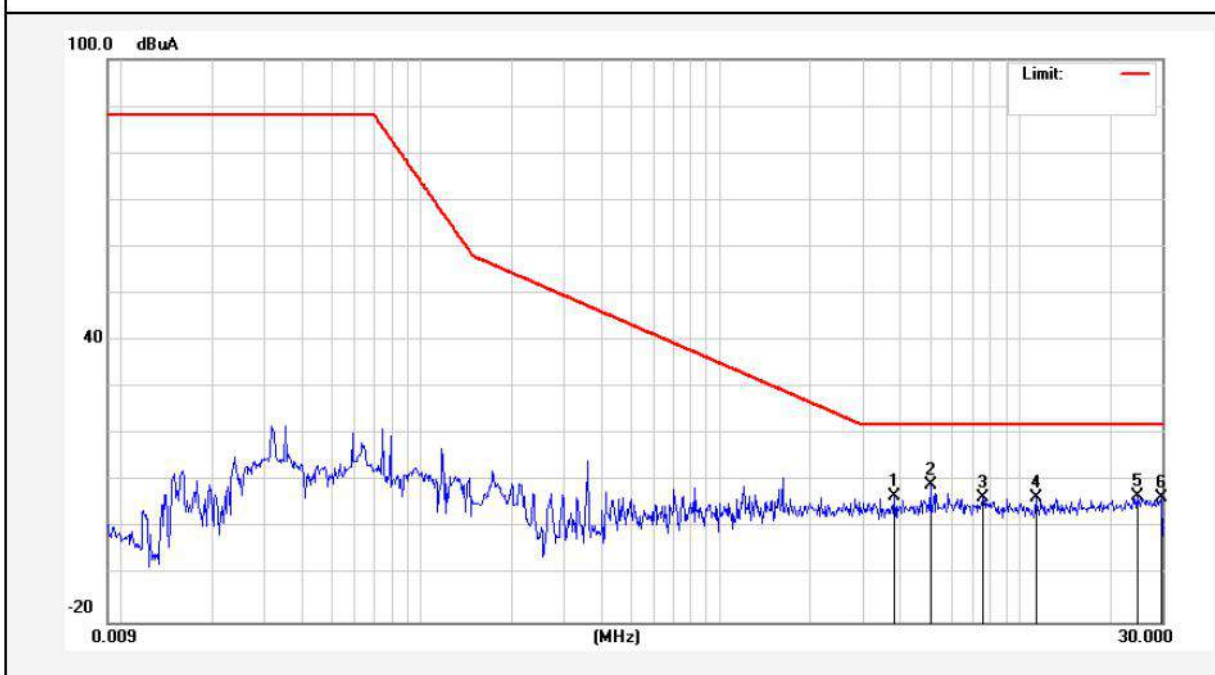

No.	Freq. (MHz)	Reading (dBuA)	Factor (dB)	Result (dBuA)	Limit (dBuA)	Over Limit (dB)	Detector	Remark
1	3.8222	6.68	0.03	6.71	22.00	-15.29	QP	
2	5.0357	9.26	0.04	9.30	22.00	-12.70	QP	
3	7.5548	6.55	0.07	6.62	22.00	-15.38	QP	
4	11.3338	6.63	0.01	6.64	22.00	-15.36	QP	
5	24.6929	6.88	0.02	6.90	22.00	-15.10	QP	
6	29.7576	6.60	0.02	6.62	22.00	-15.38	QP	

Note: Result=Reading+Factor Over Limit=Result-Limit

Magnetic Radiated Emission Test

Test Site: 1# Shielded Room
 Test Specification: AC 230V, 50Hz
 Comment: Y
 Temp.: 21.6°C Hum.: 58%

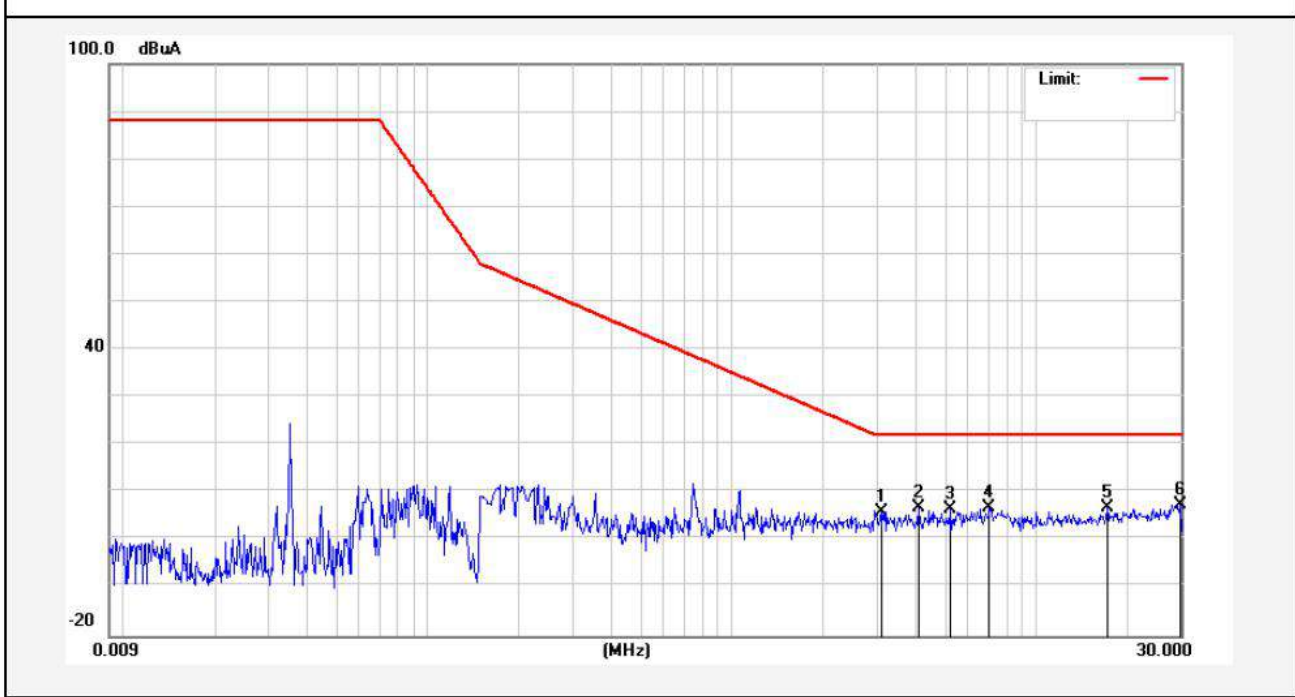

No.	Freq. (MHz)	Reading (dBuA)	Factor (dB)	Result (dBuA)	Limit (dBuA)	Over Limit (dB)	Detector	Remark
1	3.0954	6.07	0.02	6.09	22.00	-15.91	QP	
2	4.1116	6.85	0.03	6.88	22.00	-15.12	QP	
3	5.2445	6.41	0.04	6.45	22.00	-15.55	QP	
4	7.0231	6.69	0.08	6.77	22.00	-15.23	QP	
5	17.1413	6.83	0.02	6.85	22.00	-15.15	QP	
6	29.7576	7.49	0.02	7.51	22.00	-14.49	QP	

Note: Result=Reading+Factor Over Limit=Result-Limit

Magnetic Radiated Emission Test

Test Site: 1# Shielded Room
 Test Specification: AC 230V, 50Hz
 Comment: Z
 Temp.: 21.6°C Hum.: 58%

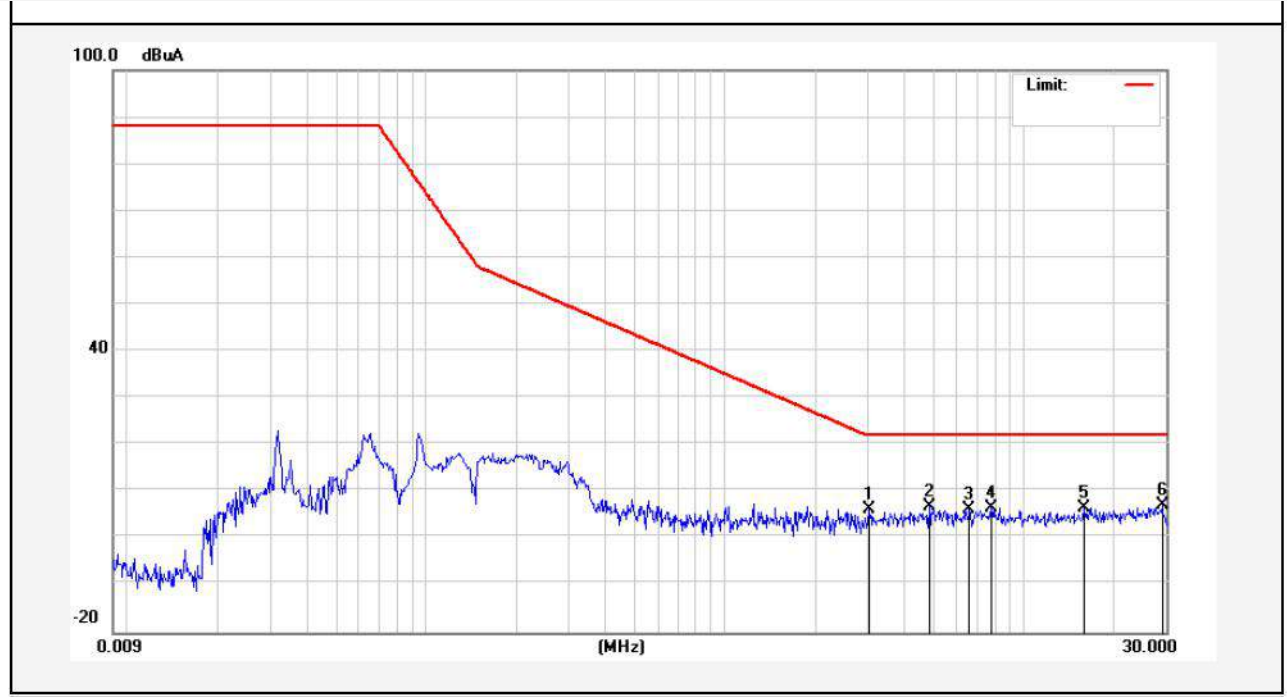

No.	Freq. (MHz)	Reading (dBuA)	Factor (dB)	Result (dBuA)	Limit (dBuA)	Over Limit (dB)	Detector	Remark
1	3.0455	6.20	0.02	6.22	22.00	-15.78	QP	
2	4.8357	6.70	0.04	6.74	22.00	-15.26	QP	
3	6.5818	6.21	0.07	6.28	22.00	-15.72	QP	
4	7.8041	6.64	0.06	6.70	22.00	-15.30	QP	
5	15.9344	6.58	0.02	6.60	22.00	-15.40	QP	
6	29.0422	7.09	0.02	7.11	22.00	-14.89	QP	

Note: Result=Reading+Factor Over Limit=Result-Limit

5. Harmonic Current Emission Test

5.1. Test Standard

Test Standard	EN IEC 61000-3-2
---------------	------------------

5.2. Test Setup

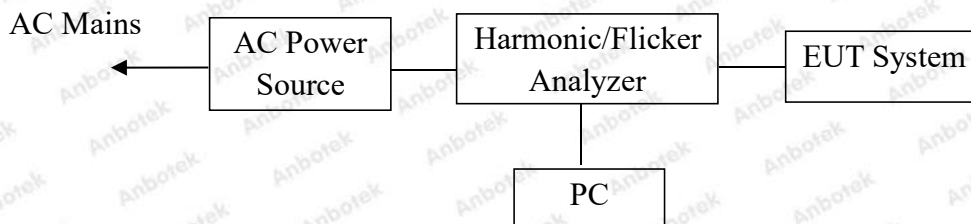

5.3. Operating Condition of EUT

- 5.3.1. Setup the EUT as shown on Section 5.2.
- 5.3.2. Turn on the power of all equipments.
- 5.3.3. After that, let the EUT work in test mode measure it.

5.4. Test Results

PASS

The test curves are shown in the following pages.

Harmonic Current Test Result Summary (Run time)

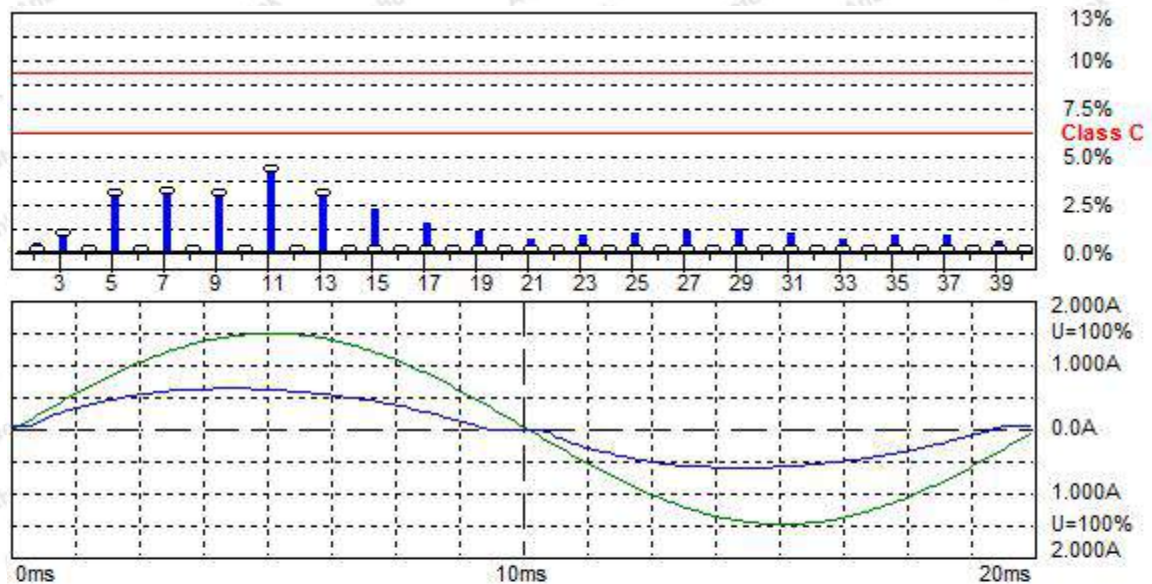

Harmonic Emission - IEC 61000-3-2, EN 61000-3-2, (EN60555-2)

Urms =	229.7 V	P =	97.87 W	THC =	0.035 A	Range:	2 A
Irms =	0.435 A	pf =	0.980	H1max =	0.433 A	V-nom:	230 V

Test aborted, Result: PASSED

HAR-1000 EMC-Partner

Full Bar : Actual Values
Empty Bar : Maximum Values
Blue : Current , Green : Voltage , Red : Failed

Harmonic Current Test Result Summary (Run time)

Urms = 229.7V Freq = 50.000 Range: 2 A
 Irms = 0.435A Ipk = 0.635A cf = 1.461
 P = 97.87W S = 99.83VA pf = 0.980
 THDi = 8.03 % THDu = 0.10 % Class C

Test - Time : 3min (100 %)

Limit Reference: H1(max)= 0.4329A pf(max)= 0.982

Test aborted, Result: PASSED

Order	Freq. [Hz]	Iavg [A]	Iavg%L [%]	Irms [A]	Irms% [%]	Irms%L [%]	Imax [A]	Imax%L [%]	Limit [A]	Status
1	50	0.4328		0.4329	99.607		0.4329			
2	100	0.0000	0.0000	0.0002	0.0562	2.8201	0.0005	5.6402	0.0087	
3	150	0.0176	13.778	0.0176	4.0449	13.778	0.0176	13.778	0.1276	
4	200	0.0000		0.0002	0.0562		0.0004			
5	250	0.0203	46.798	0.0203	4.6629	46.813	0.0203	46.813	0.0433	
6	300	0.0000		0.0002	0.0562		0.0002			
7	350	0.0145	47.941	0.0145	3.3427	47.941	0.0145	47.941	0.0303	
8	400	0.0000		0.0002	0.0562		0.0002			
9	450	0.0101	46.724	0.0101	2.3315	46.813	0.0101	46.813	0.0216	
10	500	0.0000		0.0002	0.0562		0.0002			
11	550	0.0086	66.396	0.0087	1.9944	66.742	0.0087	66.742	0.0130	
12	600	0.0000		0.0002	0.0562		0.0002			
13	650	0.0061	46.853	0.0061	1.4045	47.001	0.0061	47.001	0.0130	
14	700	0.0000		0.0002	0.0562		0.0002			
15	750	0.0000	0.0000	0.0043	0.9831	32.901	0.0044	33.841	0.0130	
16	800	0.0000		0.0002	0.0562		0.0002			
17	850	0.0000	0.0000	0.0028	0.6461	21.621	0.0028	21.621	0.0130	
18	900	0.0000		0.0002	0.0562		0.0002			
19	950	0.0000	0.0000	0.0018	0.4213	14.100	0.0020	15.040	0.0130	
20	1000	0.0000		0.0002	0.0562		0.0002			
21	1050	0.0000	0.0000	0.0009	0.1966	6.5802	0.0010	7.5202	0.0130	
22	1100	0.0000		0.0002	0.0562		0.0002			
23	1150	0.0000	0.0000	0.0015	0.3371	11.280	0.0015	11.280	0.0130	
24	1200	0.0000		0.0002	0.0562		0.0002			
25	1250	0.0000	0.0000	0.0018	0.4213	14.100	0.0018	14.100	0.0130	
26	1300	0.0000		0.0002	0.0562		0.0002			
27	1350	0.0000	0.0000	0.0018	0.4213	14.100	0.0020	15.040	0.0130	
28	1400	0.0000		0.0002	0.0562		0.0002			
29	1450	0.0000	0.0000	0.0021	0.4775	15.980	0.0021	15.980	0.0130	
30	1500	0.0000		0.0002	0.0562		0.0002			
31	1550	0.0000	0.0000	0.0017	0.3933	13.160	0.0017	13.160	0.0130	
32	1600	0.0000		0.0002	0.0562		0.0002			
33	1650	0.0000	0.0000	0.0010	0.2247	7.5202	0.0010	7.5202	0.0130	
34	1700	0.0000		0.0002	0.0562		0.0002			
35	1750	0.0000	0.0000	0.0015	0.3371	11.280	0.0015	11.280	0.0130	
36	1800	0.0000		0.0002	0.0562		0.0002			
37	1850	0.0000	0.0000	0.0015	0.3371	11.280	0.0015	11.280	0.0130	
38	1900	0.0000		0.0002	0.0562		0.0002			
39	1950	0.0000	0.0000	0.0009	0.1966	6.5802	0.0009	6.5802	0.0130	
40	2000	0.0000		0.0002	0.0562		0.0002			

6. Voltage Fluctuations & Flicker Test

6.1. Test Standard

Test Standard	EN 61000-3-3
---------------	--------------

6.2. Test Setup

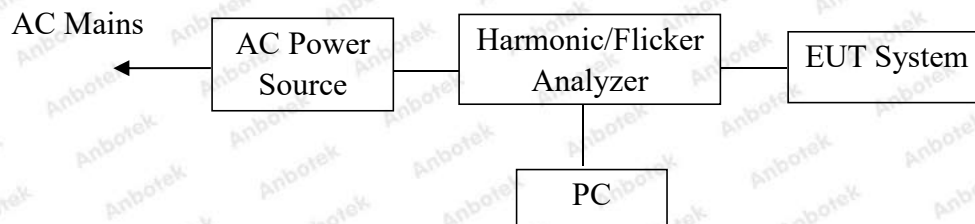

6.3. Operating Condition of EUT

- 6.3.1. Setup the EUT as shown on Section 6.2.
- 6.3.2. Turn on the power of all equipments.
- 6.3.3. After that, let the EUT work in test mode measure it.

6.4. Test Results

PASS

The test curves are shown in the following pages.

Flicker Test Summary per EN/IEC61000-3-3 (Run time)

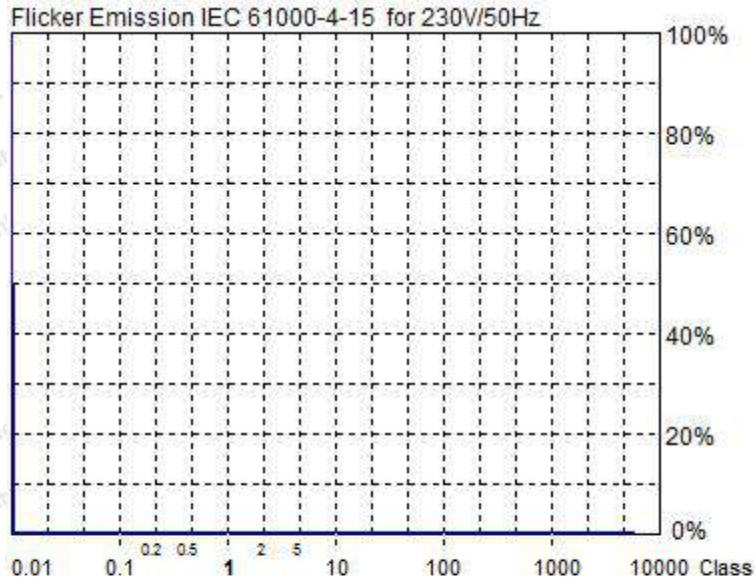

Actual Flicker (Fli):	0.00
Short-term Flicker (Pst):	0.07
Limit (Pst):	1.00
Long-term Flicker (Plt):	0.00
Limit (Plt):	0.65
Maximum Relative Volt. Change (dmax):	0.00%
Limit (dmax):	4.00%
Relative Steady-state Voltage Change (dc):	0.00%
Limit (dc):	3.00%
Tmax 3.30% (dt):	0.00ms
Limit (dt>Lim):	500ms

Flicker Emission - IEC 61000-3-3, EN 61000-3-3

Urms =	229.5 V	P =	97.09 W
Irms =	0.432 A	pf =	0.980

Range: 2 A
V-nom: 230 V

Test aborted, Result: PASSED

HAR-1000 EMC-Partner

Full Bar : Actual Values
Empty Bar : Maximum Values
Circles : Average Values
Blue : Current , Green : Voltage , Red : Failed

Urms =	229.5V	Freq =	50.000	Range:	2 A
Irms =	0.432A	lpk =	0.632A	cf =	1.464
P =	97.09W	S =	99.07VA	pf =	0.980

Test - Time : 1 x 10min = 10min (100%)

LIN (Line Impedance Network) : L: 0.24ohm +j0.15ohm N: 0.16ohm +j0.10ohm

Limits :	Plt : 0.65	Pst : 1.00
	dmax : 4.00 %	dc : 3.00 %
	dtLim: 3.30 %	dt>Lim: 500ms

Test aborted, Result: PASSED

	dmax	dc	dt>Lim
	[%]	[%]	[ms]
1	0.000	0.000	0.000

7. Electrostatic Discharge Immunity Test

7.1. Test Standard and Level

Test Standard:	EN 61547 (IEC 61000-4-2)
Performance Criterion:	B
Severity Level: 3 / Air Discharge: ± 8 kV, Level: 2 / Contact Discharge: ± 4 kV	

Test Level

Level	Test Voltage Contact Discharge (kV)	Test Voltage Air Discharge (kV)
1.	± 2	± 2
2.	± 4	± 4
3.	± 6	± 8
4.	± 8	± 15
X	Special	Special

7.2. Test Setup

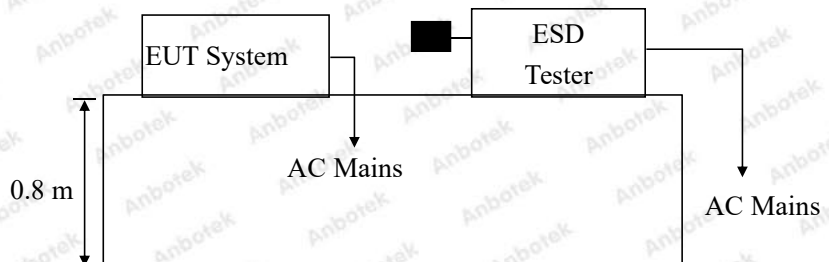

7.3. EUT Configuration on Measurement

The following equipments are installed on Electrostatic Discharge immunity Measurement to meet EN 61547 requirements and operating in a manner which tends to maximize its emission characteristics in a normal application.

7.4. Operating Condition of EUT

7.4.1. Setup the EUT as shown on Section 7.2.

7.4.2. Turn on the power of all equipments.

7.4.3. After that, let the EUT work in test mode measure it.

7.5. Test Procedure

7.5.1. Air Discharge:

This test is done on a non-conductive surface. The round discharge tip of the discharge electrode shall be approached as fast as possible to touch the EUT. After each discharge, the discharge electrode shall be removed from the EUT. The generator is then re-triggered for a new single discharge and repeated 10 times for each pre-selected test point. This procedure shall be repeated until all the air discharge completed.

7.5.2. Contact Discharge:

All the procedure shall be same as Section 7.5.1. except that the tip of the discharge electrode shall touch the EUT before the discharge switch is operated.

7.5.3. Indirect discharge for horizontal coupling plane

At least 20 single discharges shall be applied to the horizontal coupling plane, at points on each side of the EUT. The discharge electrode positions vertically at a distance of 0.1m from the EUT and with the discharge electrode touching the coupling plane.

7.5.4. Indirect discharge for vertical coupling plane

At least 20 single discharge shall be applied to the center of one vertical edge of the coupling plane. The coupling plane, of dimensions 0.5m × 0.5m, is placed parallel to, and positioned at a distance of 0.1m from the EUT. Discharges shall be applied to the coupling plane, with this plane in sufficient different positions that the four faces of the EUT are completely illuminated.

7.6. Test Results

PASS

Please refer to the following page.

Electrostatic Discharge Test Results

Air discharge :	±8.0kV	Temperature :	23.9℃
Contact discharge :	±4.0kV	Humidity :	50%
Power Supply :	AC 230V, 50Hz	Expert conclusion :	A
Test Result :	<input checked="" type="checkbox"/> Pass <input type="checkbox"/> Fail		
# For each point positive 10 times and negative 10 times discharge			
Location		Kind A-Air Discharge C-Contact Discharge	Result
Metal	4 points	C	<input checked="" type="checkbox"/> A <input type="checkbox"/> B <input type="checkbox"/> C <input type="checkbox"/> D
Light	4 points	A	<input checked="" type="checkbox"/> A <input type="checkbox"/> B <input type="checkbox"/> C <input type="checkbox"/> D
Slot	4 points	C	<input checked="" type="checkbox"/> A <input type="checkbox"/> B <input type="checkbox"/> C <input type="checkbox"/> D
HCP	4 points	C	<input checked="" type="checkbox"/> A <input type="checkbox"/> B <input type="checkbox"/> C <input type="checkbox"/> D
VCP of the front	4 points	C	<input checked="" type="checkbox"/> A <input type="checkbox"/> B <input type="checkbox"/> C <input type="checkbox"/> D
VCP of the rear	4 points	C	<input checked="" type="checkbox"/> A <input type="checkbox"/> B <input type="checkbox"/> C <input type="checkbox"/> D
VCP of the left	4 points	C	<input checked="" type="checkbox"/> A <input type="checkbox"/> B <input type="checkbox"/> C <input type="checkbox"/> D
VCP of the right	4 points	C	<input checked="" type="checkbox"/> A <input type="checkbox"/> B <input type="checkbox"/> C <input type="checkbox"/> D
Remark: Discharge should be considered on Contact and Air and Horizontal Coupling Plane (HCP) and Vertical Coupling Plane (VCP).			

8. RF Field Strength Susceptibility Test

8.1. Test Standard and Level

Test Standard:	EN 61547 (IEC 61000-4-3)
Required Performance:	A
Frequency Range:	80MHz to 1000MHz
Field Strength:	3 V/m
Modulation:	1kHz Sine Wave, 80%, AM Modulation
Frequency Step:	1 % of preceding frequency value
Polarity of Antenna:	Horizontal and Vertical
Test Distance:	3 m
Antenna Height:	1.5 m
Dwell Time:	at least 0.5s

8.2. Test Setup

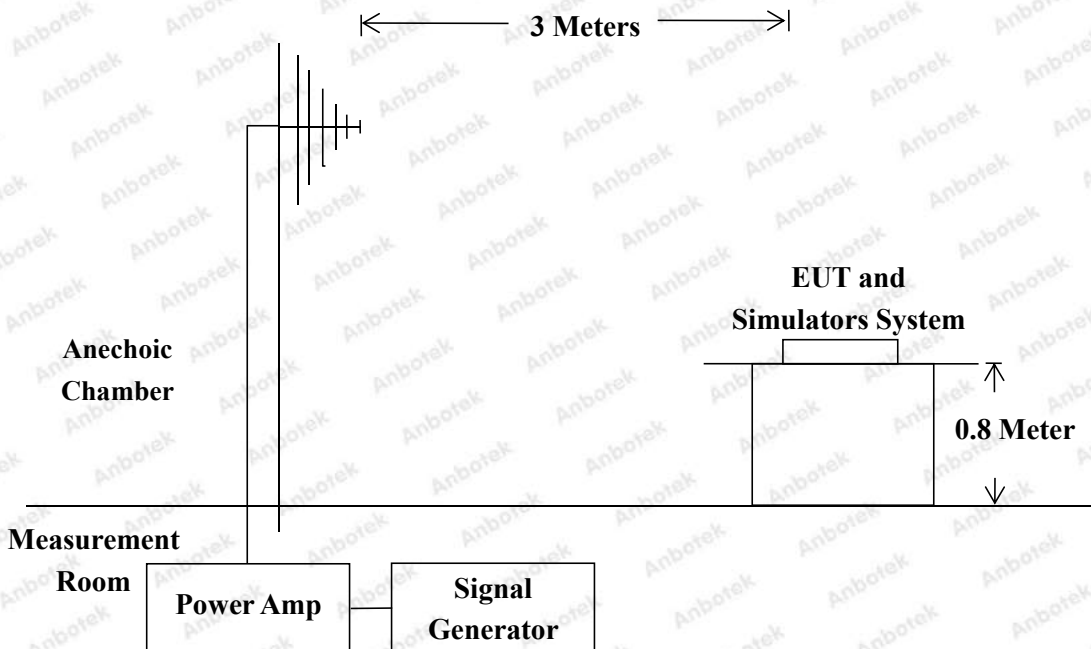

8.3. EUT Configuration on Measurement

The following equipments are installed on RF Field Strength susceptibility Measurement to meet EN 61547 requirements and operating in a manner which tends to maximize its emission characteristics in a normal application.

8.4. Operating Condition of EUT

- 8.4.1. Setup the EUT as shown on Section 8.2.
- 8.4.2. Turn on the power of all equipments.
- 8.4.3. After that, let the EUT work in test mode measure it.

8.5. Test Procedure

The EUT and support equipment, which are placed on a table that is 0.8 meter above ground and the testing was performed in a fully-anechoic chamber. The testing distance from antenna to the EUT was 3 meters.

- 1) The field strength level was 3V/m.
- 2) The frequency range is swept from 80 MHz to 1000 MHz with the signal 80% amplitude modulated with a 1kHz sine wave.
- 3) The dwell time at each frequency shall be not less than the time necessary for the EUT to be able to respond, but shall in no case be less than 0.5s.
- 4) The test was performed with the EUT exposed to both vertically and horizontally polarized fields on each of the four sides.

8.6. Measuring Results

PASS

Please refer to the following page.

RF Field Strength Susceptibility Test Results

Field Strength :	3V/m	Temperature :	23.9℃
Expert conclusion :	A	Humidity :	50%
Power Supply :	AC 230V, 50Hz	Test Result :	<input checked="" type="checkbox"/> Pass <input type="checkbox"/> Fail
Dwell Time:	1s		

Frequency Range (MHz)	Antenna Polarity	R.F. Field Strength	Azimuth	Result
80~1000	H / V	3 V/m (rms)	Front	<input checked="" type="checkbox"/> A <input type="checkbox"/> B <input type="checkbox"/> C <input type="checkbox"/> D
			Rear	
			Left	
			Right	

9. Electrical Fast Transient/Burst Immunity Test

9.1. Test Standard and Level

Test Standard:	EN 61547 (IEC 61000-4-4)
Performance criterion:	B
Severity Level 2: 1.00kV	

Test Level

Open Circuit Output Test Voltage $\pm 10\%$		
Level	On Power Supply Lines (kV)	On I/O (Input/Output) Signal data and control lines (kV)
1.	0.50	0.25
2.	1.00	0.50
3.	2.00	1.00
4.	4.00	2.00
X.	Special	Special

9.2. Test Setup

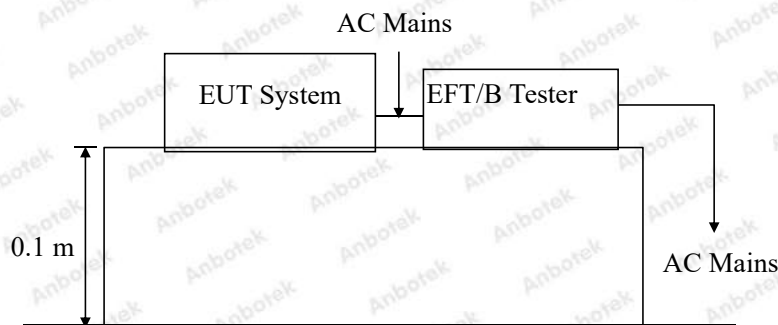

9.3. EUT Configuration on Measurement

The following equipments are installed on Electrical Fast Transient/Burst Immunity Measurement to meet EN 61547 requirements and operating in a manner which tends to maximize its emission characteristics in a normal application.

9.4. Operating Condition of EUT

9.4.1. Setup the EUT as shown in Section 9.2.

9.4.2. Turn on the power of all equipments.

9.4.3. Let the EUT work in test mode and measure it.

9.5. Test Procedure

The EUT is put on the table which is 0.1 meter high above the ground. This reference ground plane shall project beyond the EUT by at least 0.1m on all sides and the minimum distance between EUT and all other conductive structure, except the ground plane beneath the EUT, shall be more than 0.5m.

9.5.1. For input and output AC power ports:

The EUT is connected to the power mains by using a coupling device which couples the EFT interference signal to AC power lines. Both polarities of the test voltage should be applied during compliance test and the duration of the test is 2 mins.

9.5.2. For signal lines and control lines ports:

Select tests based on product characteristics.

9.5.3. For DC output line ports:

Select tests based on product characteristics.

9.6. Test Results

PASS

Please refer to the following page.

Electrical Fast Transient/Burst Test Results

Ambient Condition : 23.9℃ / 50% RH		Expert conclusion : A	
Power Supply : AC 230V, 50Hz		Test Result : <input checked="" type="checkbox"/> Pass <input type="checkbox"/> Fail	
Inject Line : AC Mains		Inject Method: Direct	Inject Time(s): 120
Line	Polarity	Test Voltage (kV)	Result
AC Line	±	1.00kV	<input checked="" type="checkbox"/> A <input type="checkbox"/> B <input type="checkbox"/> C <input type="checkbox"/> D
DC Line			
Signal Line			

10. Surge Immunity Test

10.1. Test Standard and Level

Test Standard:	EN 61547 (IEC 61000-4-5)
Performance criterion:	C
Severity Level 2, Line to Line: 1.0kV; Severity Level 3, Line to Earth: 2.0kV	

Test Level

Severity Level	Open-Circuit Test Voltage (kV)
1.	0.5
2.	1.0
3.	2.0
4.	4.0
X.	Special

10.2. Test Setup

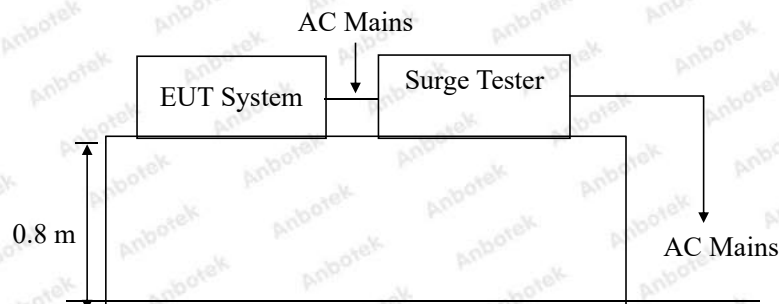

10.3. EUT Configuration on Measurement

The following equipments are installed on Surge immunity Measurement to meet EN 61547 requirements and operating in a manner which tends to maximize its emission characteristics in a normal application.

10.4. Operating Condition of EUT

- 10.4.1. Setup the EUT as shown in Section 10.2.
- 10.4.2. Turn on the power of all equipments.
- 10.4.3. Let the EUT work in test mode and measure it.

10.5. Test Procedure

10.5.1. Set up the EUT and test generator as shown on Section 10.2.

10.5.2. For line to line coupling mode, provide a 1.0 kV 1.2/50us voltage surge (at open-circuit condition) and 8/20us current surge to EUT selected points.

10.5.3. For line to earth coupling mode, provide a 2.0 kV 1.2/50us voltage surge (at open-circuit condition) and 8/20us current surge to EUT selected points.

10.5.4. At least 5 positive and 5 negative (polarity) tests with a maximum 1/min repetition rate are conducted during test.

10.5.5. Different phase angles are done individually.

10.5.6. Record the EUT operating situation during compliance test and decide the EUT immunity criterion for above each test.

10.6. Test Results

PASS

Please refer to the following page.

Surge Immunity Test Results

Humidity :	50%	Temperature :	23.9℃		
Power Supply :	AC 230V, 50Hz	Expert conclusion:	A		
Test Result :	<input checked="" type="checkbox"/> Pass <input type="checkbox"/> Fail				
Location	Polarity	Phase Angle	Number of Pulse	Pulse Voltage (kV)	Result
L-N	+	<input type="checkbox"/> 0° <input checked="" type="checkbox"/> 90° <input type="checkbox"/> 180° <input type="checkbox"/> 270°	5	1.0kV	<input checked="" type="checkbox"/> A <input type="checkbox"/> B <input type="checkbox"/> C <input type="checkbox"/> D
L-N	-	<input type="checkbox"/> 0° <input type="checkbox"/> 90° <input type="checkbox"/> 180° <input checked="" type="checkbox"/> 270°	5	1.0kV	<input checked="" type="checkbox"/> A <input type="checkbox"/> B <input type="checkbox"/> C <input type="checkbox"/> D
L-GND	+	<input type="checkbox"/> 0° <input checked="" type="checkbox"/> 90° <input type="checkbox"/> 180° <input type="checkbox"/> 270°	5	2.0kV	<input checked="" type="checkbox"/> A <input type="checkbox"/> B <input type="checkbox"/> C <input type="checkbox"/> D
L-GND	-	<input type="checkbox"/> 0° <input type="checkbox"/> 90° <input type="checkbox"/> 180° <input checked="" type="checkbox"/> 270°	5	2.0kV	<input checked="" type="checkbox"/> A <input type="checkbox"/> B <input type="checkbox"/> C <input type="checkbox"/> D
N-GND	+	<input type="checkbox"/> 0° <input checked="" type="checkbox"/> 90° <input type="checkbox"/> 180° <input type="checkbox"/> 270°	5	2.0kV	<input checked="" type="checkbox"/> A <input type="checkbox"/> B <input type="checkbox"/> C <input type="checkbox"/> D
N-GND	-	<input type="checkbox"/> 0° <input type="checkbox"/> 90° <input type="checkbox"/> 180° <input checked="" type="checkbox"/> 270°	5	2.0kV	<input checked="" type="checkbox"/> A <input type="checkbox"/> B <input type="checkbox"/> C <input type="checkbox"/> D

11. Injected Currents Susceptibility Test

11.1. Test Standard and Level

Test Standard:	EN 61547 (IEC 61000-4-6)
Performance criterion:	A
Severity Level 2: 3V (rms), (0.15MHz ~80MHz)	

Test Level

Level	Field Strength V
1.	1
2.	3
3.	10
X.	Special

11.2. Test Setup

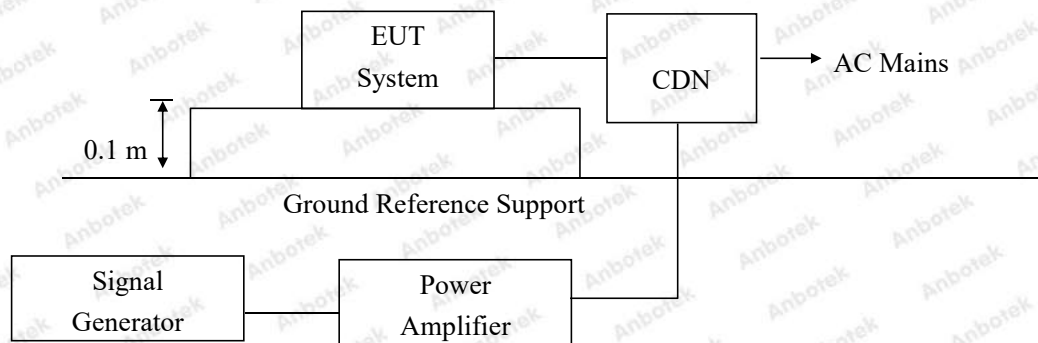

11.3. EUT Configuration

The following equipments are installed on currents susceptibility Measurement to meet EN 61547 requirements and operating in a manner which tends to maximize its emission characteristics in a normal application.

11.4. Operating Condition of EUT

- 11.4.1. Setup the EUT as shown in Section 11.2.
- 11.4.2. Turn on the power of all equipments.
- 11.4.3. Let the EUT work in test mode and measure it.

11.5. Test Procedure

- 1) Set up the EUT, CDN and test generators as shown on Section 11.2.
- 2) Let the EUT work in test mode and measure it.
- 3) The EUT are placed on an insulating support 0.1m high above a ground reference plane. CDN (coupling and decoupling device) is placed on the ground plane about 0.3m from EUT. Cables between CDN and EUT are as short as possible, and their height above the ground reference plane shall be between 30 and 50 mm (where possible).
- 4) The disturbance signal described below is injected to EUT through CDN.
- 5) The EUT operates within its operational mode(s) under intended climatic conditions after power on.
- 6) The frequency range is swept from 150KHz to 80MHz using 3V signal level, and with the disturbance signal 80% amplitude modulated with a 1KHz sine wave.
- 7) The rate of sweep shall not exceed $1.5 \cdot 10^{-3}$ decades/s. Where the frequency is swept incrementally, the step size shall not exceed 1% of the start and thereafter 1% of the preceding frequency value.
- 8) Recording the EUT operating situation during compliance testing and decide the EUT immunity criterion.

11.6. Test Results

PASS

Please refer to the following page.

Injected Currents Susceptibility Test Results

Humidity : 50%		Temperature : 23.9℃	
Power Supply : AC 230V, 50Hz		Expert conclusion: A	
Test Result : <input checked="" type="checkbox"/> Pass <input type="checkbox"/> Fail			
Frequency Range (MHz)	Injected Position	Strength (Unmodulated)	Result
0.15 ~ 80	AC Mains	3V	<input checked="" type="checkbox"/> A <input type="checkbox"/> B <input type="checkbox"/> C <input type="checkbox"/> D
Remark : 1. Modulation Signal:1KHz 80% AM			

12. Voltage Dips And Interruptions Test

12.1. Test Standard and Level

Test Standard:	EN 61547 (IEC 61000-4-11)
Performance Criterion:	B&C

Test Level		
Test Level %UT	Voltage dip and short interruptions %UT	Duration (in period)
0	100	0.5
70	30	10 *

12.2. Test Setup

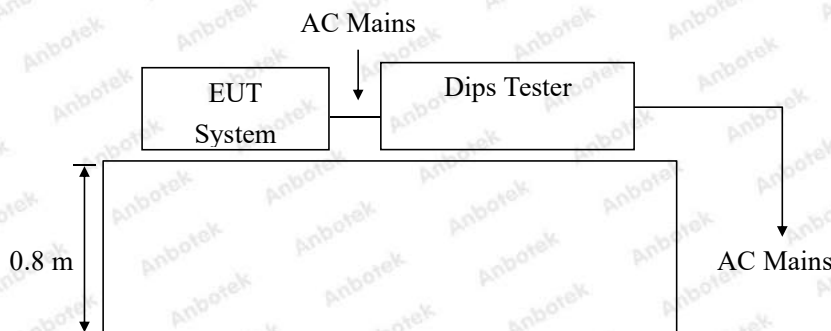

12.3. EUT Configuration on Measurement

The following equipments are installed on Voltage dips and interruptions Measurement to meet EN 61547 requirements and operating in a manner which tends to maximize its emission characteristics in a normal application.

12.4. Operating Condition of EUT

12.4.1. Setup the EUT as shown in Section 12.2.

12.4.2. Turn on the power of all equipments.

12.4.3. Let the EUT work in test mode and measure it.

12.5. Test Procedure

- 1) Set up the EUT and test generator as shown on Section 12.2.
- 2) The interruptions is introduced at selected phase angles with specified duration.
- 3) Record any degradation of performance.

12.6. Test Results

PASS

Please refer to the following page.

Voltage Dips and Interruptions Test Results

Temperature : 23.9°C		Humidity : 50%	
Power Supply : AC 230V, 50Hz		Expert conclusion : B&C	
Test Result : <input checked="" type="checkbox"/> Pass <input type="checkbox"/> Fail			
Test Level % UT	Voltage Dips % UT	Duration (in periods)	Result
70	30	10P	<input type="checkbox"/> A <input type="checkbox"/> B <input checked="" type="checkbox"/> C <input type="checkbox"/> D
Test Level % UT	Short Interruptions % UT	Duration (in periods)	Result
0	100	0.5P	<input type="checkbox"/> A <input checked="" type="checkbox"/> B <input type="checkbox"/> C <input type="checkbox"/> D

APPENDIX I -- TEST SETUP PHOTOGRAPH

Photo of Power Line Conducted Emission Test



Photo of Radiated Emission Test



Photo of Magnetic Radiated Emission Test



Photo of Flicker/ Harmonic Test



Photo of Electrostatic Discharge Immunity Test



Photo of RF Field Strength susceptibility Test



Photo of Electrical Fast Transient/Burst Immunity Test

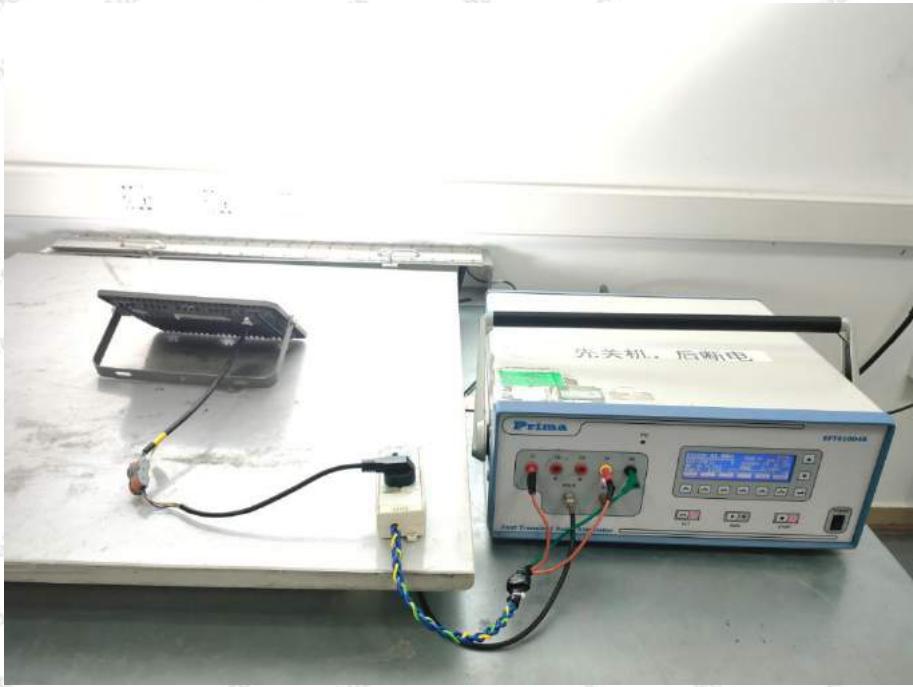

Photo of Surge Immunity Test



Photo of Injected currents susceptibility Test

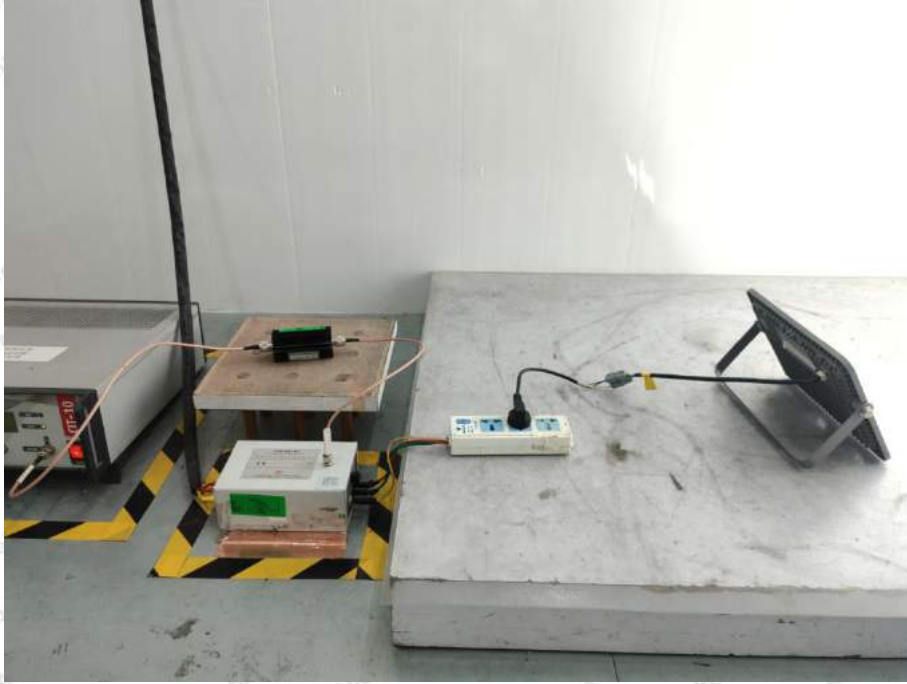
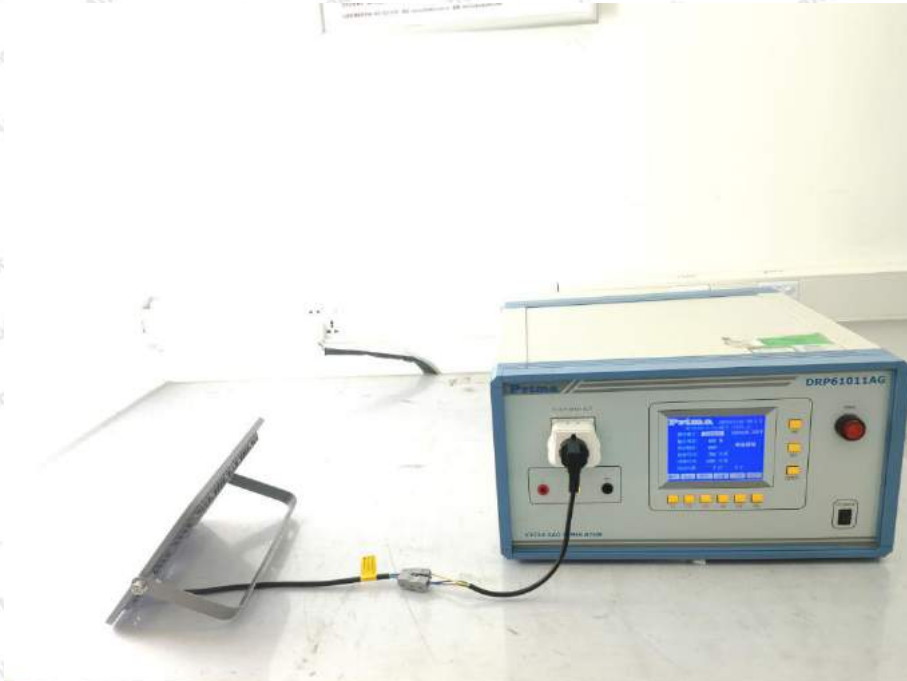

Photo of Voltage Dips and Interruptions Test



APPENDIX II -- Photo documentation



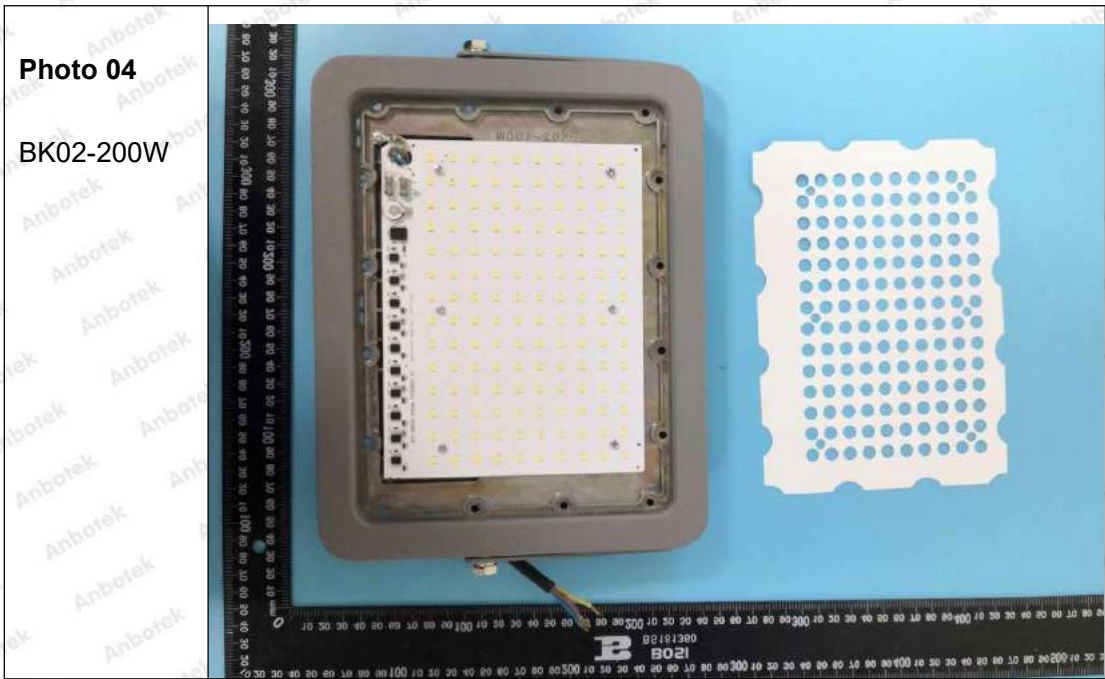
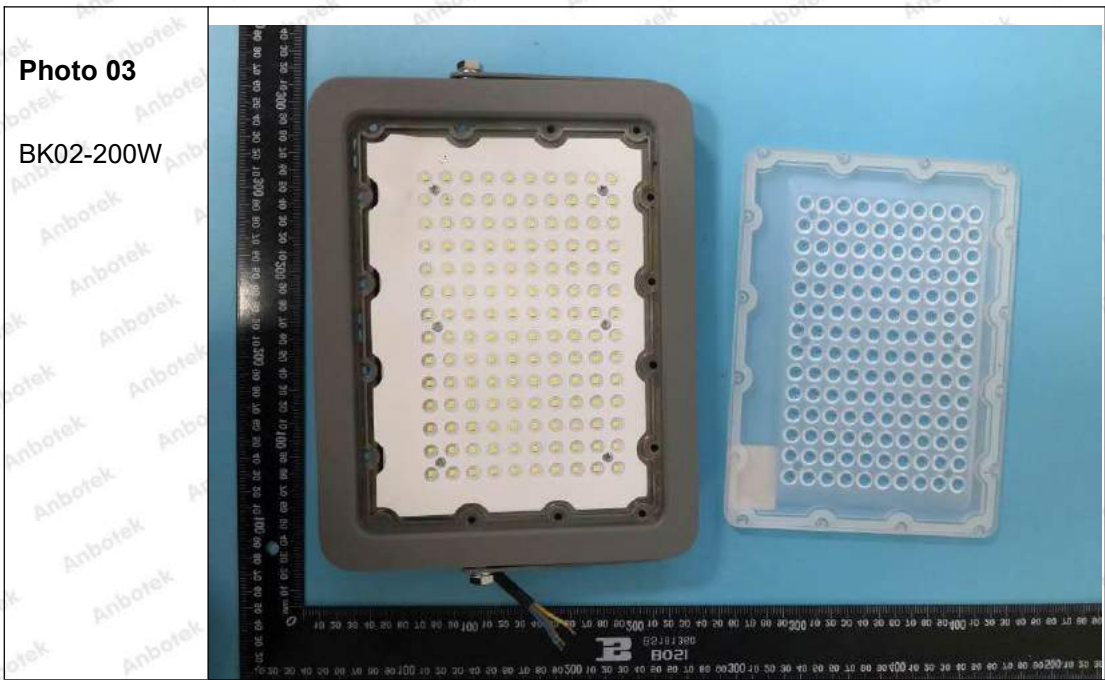

Photo 05

BK02-200W

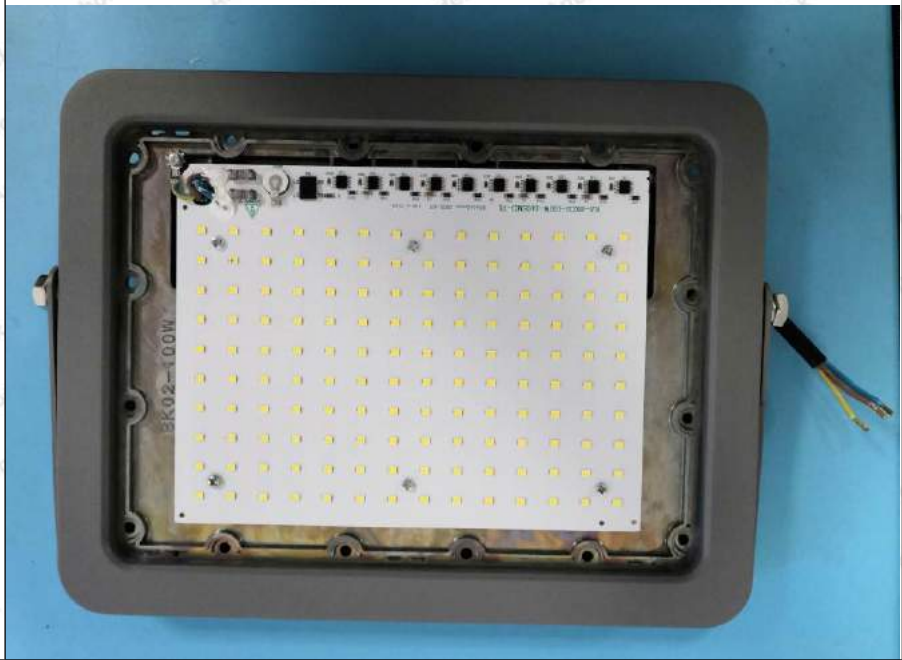

Photo 06

BK02-200W

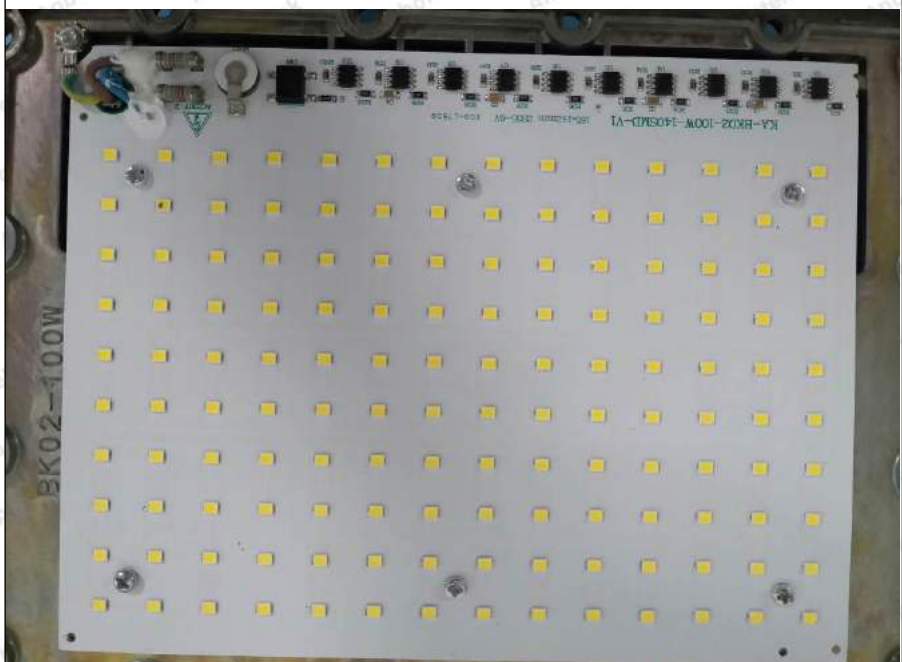

Photo 07

BK02-100W



Photo 08

BK02-100W



Photo 09

BK02-100W



CE Label

1. The CE conformity marking must consist of the initials 'CE' taking the following form:

If the CE marking is reduced or enlarged, the proportions given in the above graduated drawing must be respected.

2. The CE marking must have a height of at least 5 mm except where this is not possible on account of the nature of the apparatus.

3. The CE marking must be affixed to the product or to its data plate. Additionally it must be affixed to the packaging, if any, and to the accompanying documents.

4. The CE marking must be affixed visibly, legibly and indelibly.

It must have the same height as the initials 'CE'.

----- End of Report -----